

Version	Change NO.	Autograph	Date



2.92mm ADAPTERS F/F 40GHZ

A-29F29F-BF

SPECIFICATIONS

ELECTRICAL

VSWR: 1.20:1
 Frequency: DC-40 GHz
 Impedance: 50 Ohms

MECHANICAL

1000 Cycles Min

ENVIRONMENTAL

-55° C -- +125° C
 Corrosion: MIL-STD 202
 Vibration: MIL-STD 202

MATERIALS

Body: SU304 Polished & Passivated
 Center Contact : Beryllium Copper Gold Plated
 Insulators: PEI

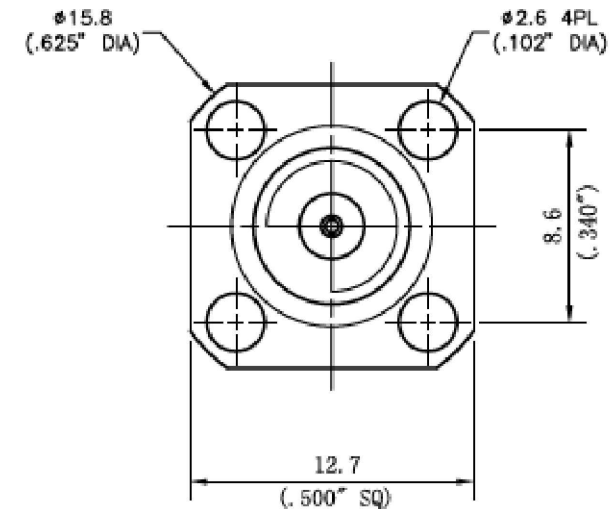
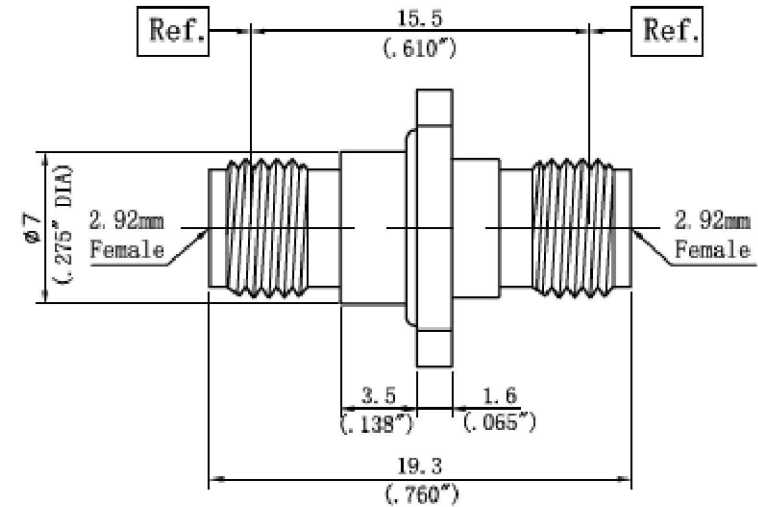

Jointly sign

Quality department
Production department
Purchasing Department

Material:	Important size	Key dimensions	Shanghai Juncoax RF Technologies Co., Ltd
Drafting: Yuan.YJ	*	▲	Material number: ZJQ-0057
Check: Ming.WM	Marker phase	Version	Proportion
Standard: Liang.DH	P	A/0	Property
Approval: Colin.tsai	Unit	mm	Model: A-29F29F-BF
ALL (1) page No. (1) page			